

SWITCH SYSTEM BIO DX FRUIT

- Châssis porté aux trois points d' élévateur
- Châssis en tubulaire sectionné
- Extension de télescope hydraulique
- N° 2 roues de support en gomme réglables
- Système hydraulique

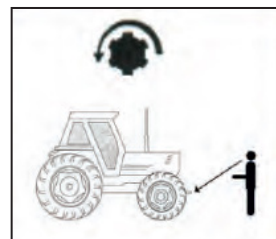

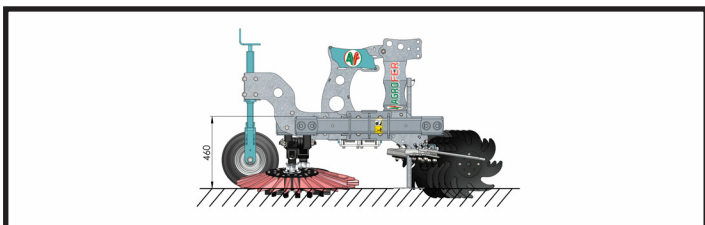
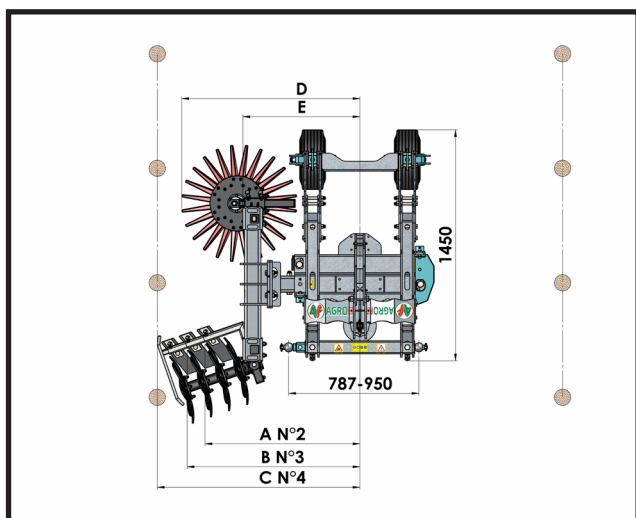
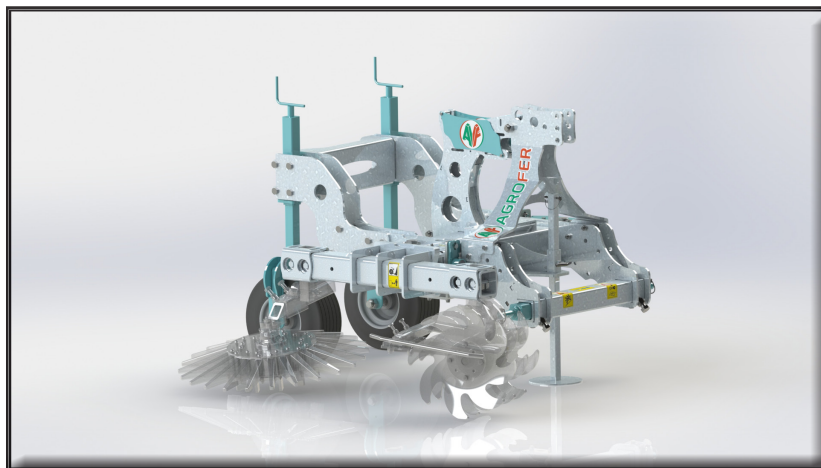

À confirmer



ANTÉRIEUR

OR

POSTÉRIEUR

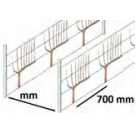
MOD. mm	Kg	A min-max	B min-max	C min-max	D min-max	E min-max	 HP	 min-max	 mm
MEDIO	da 360 a 580	1100-1600	1200-1700	1400-1900	ø540 1200-1700 ø700 1300-1800 ø950 1400-1900	800-1300	30	50-100	2000
GRANDE	da 360 a 580	1300-1800	1400-1900	1600-2100	ø540 1400-1900 ø700 1500-2100 ø950 1630-2130	1050-1550	30	50-100	2500

SWITCH SYSTEM BIO DX

- Coulisse à emboîtement hydraulique de la tête droite
- Kit porte-outils Rollacker - Kult cultivateur DX – **N.2 Sections**
- Complet : côté DX (droit)
- Tracteur avec n° 1 paire de sorties hydrauliques à double effet
- Tracteur standard Lt 20

