

SWITCH SYSTEM BIO DX

- Befestigung an den drei Punkten des Hebers
- Formrohrchassis
- Chassis reversibel vorne hinten
- Hydraulische Teleskopverlängerung
- N° 2 regulierbaren Gummistützreifen
- Hydraulische Anlage

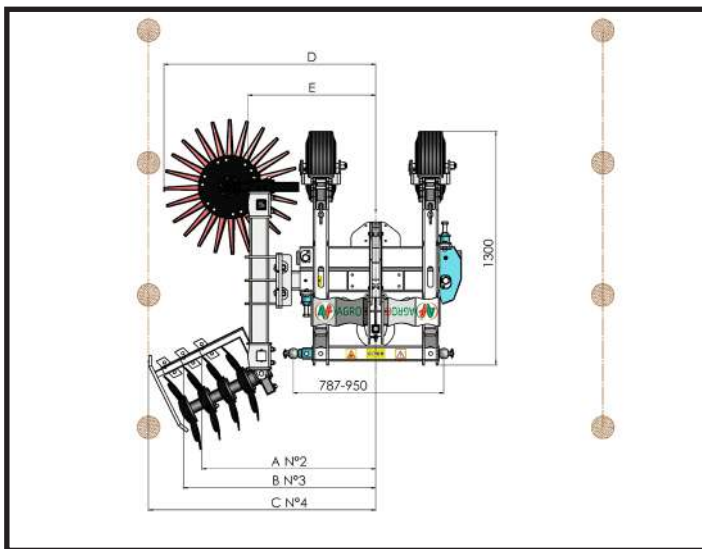

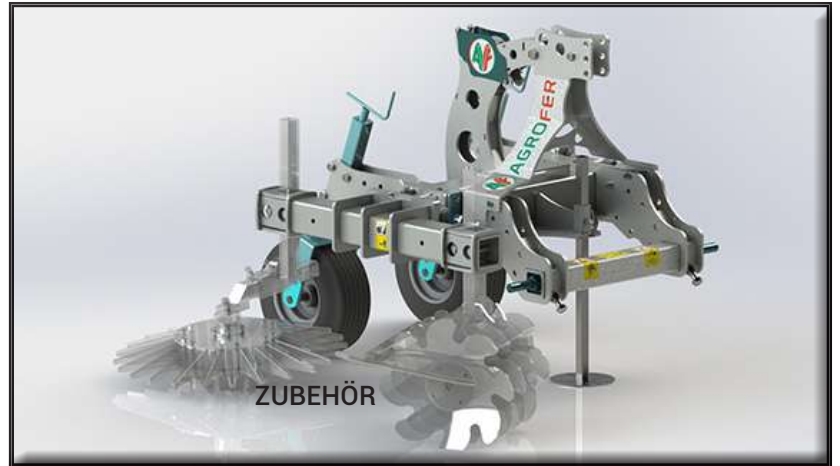
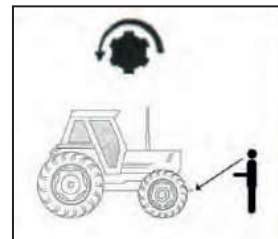

Zur Bestätigung



VORDERSEITE





**oder
RÜCKSEITE**

MOD. mm	Kg	A min-max	B min-max	C min-max	D min-max	E min-max	 HP	 min-max	 mm
PICCOLO	da 360 a 580	900-1400	1000-1500	1200-1700	ø540 1000-1500 ø700 1120-1620 ø950 1230-1730	600-1100	30	50-100	1600
MEDIO	da 360 a 580	1100-1600	1200-1700	1400-1900	ø540 1200-1700 ø700 1300-1800 ø950 1400-1900	800-1300	30	50-100	2000
GRANDE	da 360 a 580	1300-1800	1400-1900	1600-2100	ø540 1400-1900 ø700 1500-2100 ø950 1630-2130	1050-1550	30	50-100	2500

SWITCH SYSTEM BIO DX

- Hydraulische Verlängerung des Kopfs DX
- Werkzeugsatz Rollacker und Fingerhacken Kult DX
- Komplett: richtigen Seite DX
- Traktor mit 1 Paar doppelwirkenden hydraulischen Anschlüssen
- Traktor standard Lt 20

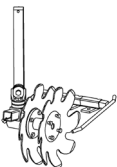
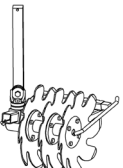
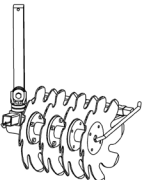
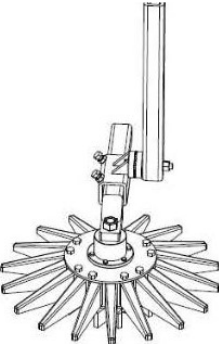
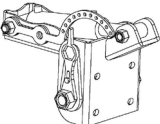
Mod. PICCOLO
Mod. MEDIO
Mod. GRANDE

BILD	CODE	BESCHREIBUNG	PREIS
	LM 012	ROLLACKER N°2 SCHEIBEN Ø380 MOD. DX Kg. 45	
	LM 012 B	ROLLACKER N°3 SCHEIBEN Ø380 MOD. DX Kg. 50	
	LM 012 E	ROLLACKER N°4 SCHEIBEN Ø380 MOD. DX Kg. 60	
	LM 011	FINGERHACKEN KULT Ø540 MOD. DX Kg. 35	
	LM 011 B	FINGERHACKEN KULT Ø700 MOD. DX Kg. 40	
	LM 011 E	FINGERHACKEN KULT Ø950 MOD. DX Kg. 50	
	LM 013 Zahl A/B/C/D/E + 100 mm	HYDRAULISCHE NEIGUNG TRAKTORÖLBETRIEB MOD. DX N ° 1 PAAR DOPPELT WIRKENDE HYDRAULIKSTECKDOSE KG 45	
	LM 017	HANDRAD MOD.DX Kg. 25	

SWITCH SYSTEM BIO DX-SX

- Befestigung an den drei Punkten des Hebbers
- Formrohrchassis
- Chassis reversibel vorne hinten
- Hydraulische Teleskopverlängerung
- N°2 regulierbaren Gummistützreifen
- Hydraulische Anlage

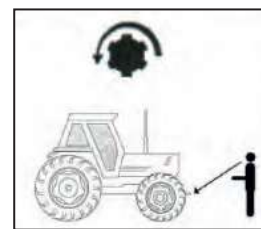
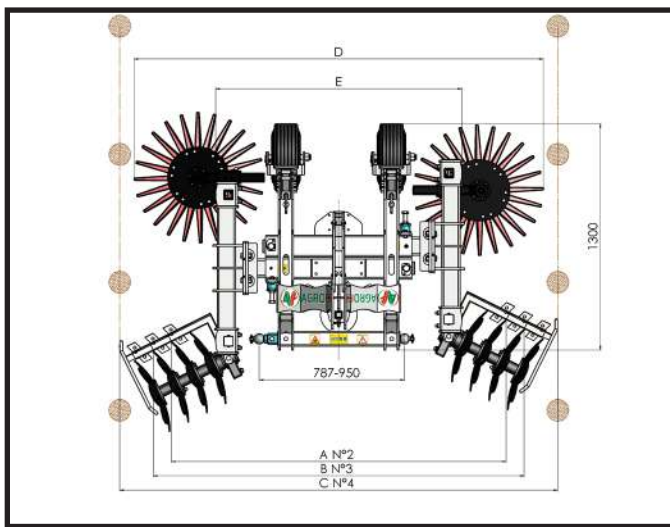
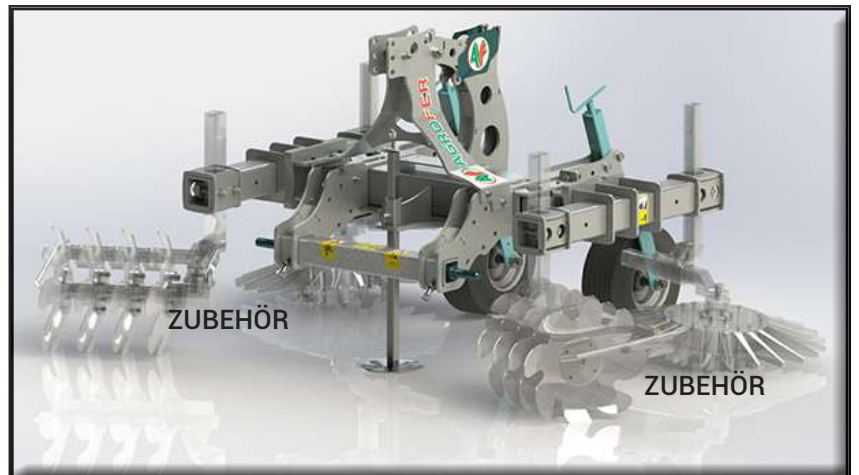

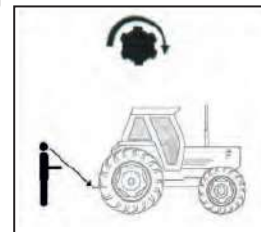

VORDERSEITE

Zur Bestätigung



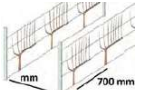

ODER
RÜCKSEITE

MOD. mm	Kg	A min-max	B min-max	C min-max	D min-max	E min-max	 HP	 min-max	 700 mm
VIGNERON	da 400 a 700	900-1400	2000-3000	1200-1700	ø540 1000-1500 ø700 1120-1620 ø950 1230-1730	1250-2550	50	50-100	1600
PICCOLO	da 400 a 700	1800-2800	2000-3000	2400-3400	ø540 1900-2900 ø700 2200-3200 ø950 2500-3500	1350-2400	50	50-100	2000
MEDIO	da 400 a 700	2200-3200	2400-3400	2800-3800	ø540 2400-3400 ø700 2600-3600 ø950 2800-3800	1700-2700	50	50-100	2500
GRANDE	da 400 a 700	2600-3600	2800-3800	3200-4200	ø540 2800-3800 ø700 3000-4000 ø950 3200-4200	2100-3100	50	50-100	3000
MAGNUM	da 400 a 700	2700-3700	2900-3900	3300-4300	ø540 3000-4000 ø700 3200-4200 ø950 3400-4400	2500-3900	50	50-100	3300

SWITCH SYSTEM BIO DX-SX

- Hydraulische Verlängerung des Kopfs DX-SX
- Werkzeugsatz Rollacker und Fingerhacken Kult DX - SX
- Komplett: richtigen und linken Seite DX-SX
- Traktor mit 1 Paar doppeltwirkenden hydraulischen Anschlüssen
- Traktor standard Lt 20

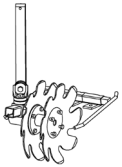
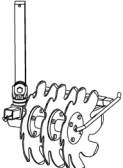
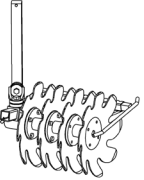
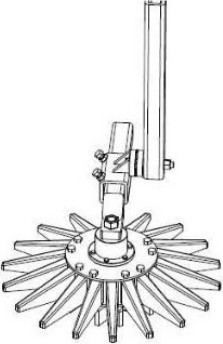
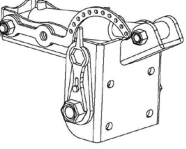

Mod. VIGNERON
Mod. PICCOLO
Mod. MEDIO
Mod. GRANDE
Mod. MAGNUM

BILD	CODE	BESCHREIBUNG	PREIS
	LM 012 C	ROLLACKER N°2 SCHEIBEN Ø380 MOD. DX - SX Kg. 90	
	LM 012 D	ROLLACKER N°3 SCHEIBEN Ø380 MOD. DX - SX Kg. 100	
	LM 012 F	ROLLACKER N°4 SCHEIBEN Ø380 MOD. DX - SX Kg. 120	
	LM 011 C	FINGERHACKEN KULT Ø540 MOD. DX - SX Kg.70	
	LM 011 D	FINGERHACKEN KULT Ø700 MOD. DX -SX Kg. 80	
	LM 011 F	FINGERHACKEN KULT Ø950 MOD. DX - SX Kg. 100	
	LM 013 B Zahl A/B/C/D/E + 100 mm	HYDRAULISCHE NEIGUNG TRAKTORÖLBETRIEB MOD. DX - SX	
	LM 017 B	HANDRAD MOD.DX - SX Kg. 50	

SWITCH SYSTEM BIO DX-SX GIGANTE

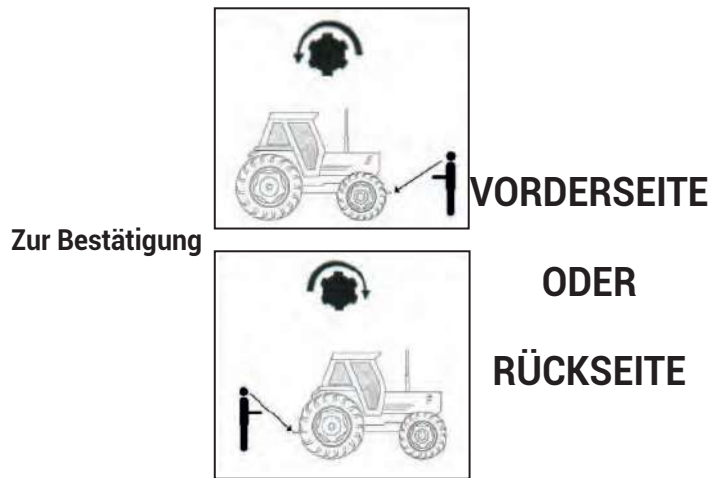
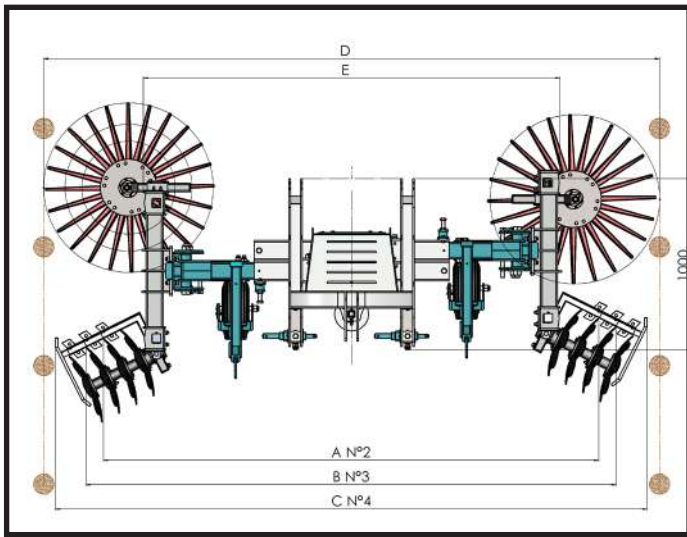
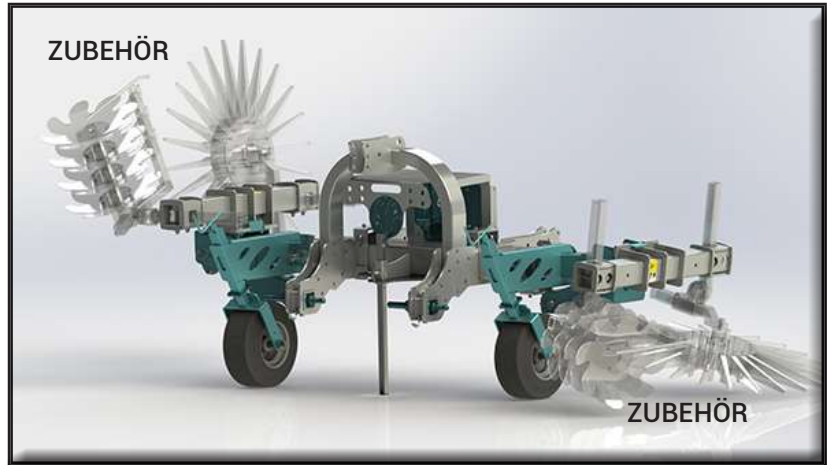
- Befestigung an den drei Punkten des Hebers
- Formrohrchassis
- Chassis reversibel vorne hinten
- Hydraulische Teleskopverlängerung
- N°2 regulierbaren Gummistützreifen
- Hydraulische Anlage

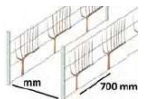

MOD. mm	Kg	A min-max	B min-max	C min-max	D min-max	E min-max	 HP	 min-max	 mm
GIGANTE	600	2900-4400	3130-4530	3490-4890	ø540 3180-4580 ø700 3380-4780 ø950 3630-5000	2450-3150	60	50-100	da 3500 a 5000

SWITCH SYSTEM BIO DX-SX GIGANTE

- Hydraulische Verlängerung des Kopfs DX-SX - Traktorölbetrieb
- 90 ° Neigung des Kopfes DX-SX
- Werkzeugsatz Rollacker und Fingerhacken Kult DX - SX
- Komplet: richtigen und linken Seite DX-SX
- Traktor mit 3 Paars doppelwirkenden hydraulischen Anschlüssen
- Traktor standard Lt 20

Mod. GIGANTE

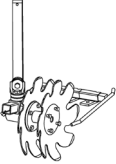
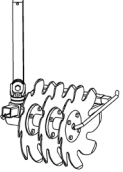
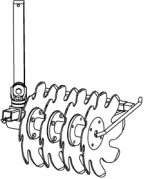
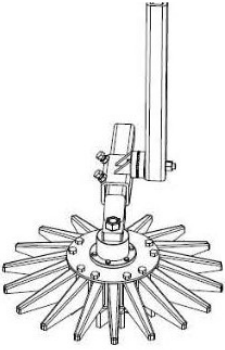
BILD	CODE	BESCHREIBUNG	PREIS
	LM 012 C	ROLLACKER N°2 SCHEIBEN Ø380 MOD. DX - SX Kg. 90	
	LM 012 D	ROLLACKER N°3 SCHEIBEN Ø380 MOD. DX - SX Kg. 100	
	LM 012 F	ROLLACKER N°4 SCHEIBEN Ø380 MOD. DX - SX Kg. 120	
	LM 011 C	FINGERHACKEN KULT Ø540 MOD. DX - SX Kg.70	
	LM 011 D	FINGERHACKEN KULT Ø700 MOD. DX -SX Kg. 80	
	LM 011 F	FINGERHACKEN KULT Ø950 MOD. DX - SX Kg. 100	